



DATE	
PROJECT	
TYPE	
NOTE	
PREPARED BY	

## CLC-2283

### CLC-2283 Induction High/Low Bay Fixture



- Lamp Rating: 100,000 Hours for enhanced safety and maintenance
- Lumen Maintenance: 88% over 100,000 Hours
- Energy Savings: Over 57% savings comparing to HPS and other HID sources
- IP Rating: IP55, UL listed for damp location
- Light Output: 5000K, 90 CRI
- Voltage: 120-277v standard, 480V optional
- Applications: Factories, warehouses, foundries, machine shops & retail stores
- Warranty: 10 year warranty (see terms and conditions)
- Construction: Heavy duty aluminum

#### Lamp Specifications

Wattage	Lumens	CRI	Pupil Lumens	CCT(KELVIN)	Rated Life
CLC-2283-250IND	23,750	90	39,187	5000K	100,000 HRS
CLC-2283-300IND	28,500	90	47,025	5000K	100,000 HRS
CLC-2283-400IND	38,000	90	62,700	5000K	100,000 HRS

#### Ballast Specifications

System Wattage	Input Voltage	Input Current	Input Frequency	Power Factor	Ambient Temp	THD
260W	120-277VAC	2.16-0.93A	233KHz	.99	-31°F- 239°F	<10%
316W	120-277VAC	2.6-1.14A	233KHz	.99	-31°F- 239°F	<10%
420W	120-277VAC	3.5-1.5A	233KHz	.99	-31°F- 239°F	<10%

#### Ordering Guide

Example: (CLC-2283-250IND-47-120/277V-WH-OS)

MODEL	WATTS	COLOR TEMP	VOLTAGE	MOUNTING	FINISH	OPTIONS
CLC-2283 HIGHBAY	250W-250IND 300W-300IND 400W-400IND	27-2700K 35-3500K 41-4100K 47-4700K 50-5000K 60-6000K	120-277V 480V	HANGING WITH HOOK	WH-WHITE ANZ-ANODIZED CUS-CUSTOM	OS-OCCUPANCY SENSOR

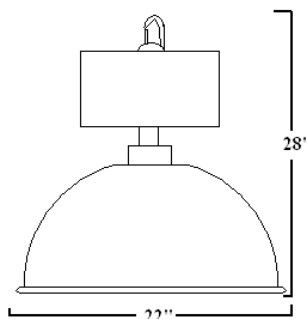

\*IC technology generator for power surge & spikes

All our products are proudly manufactured and or assembled in USA and we are proud to announce that we are "BUY AMERICAN" compliant.